

# zernikes12 (Zernikes9)

b2boptic → items → item → pair → patient → iProfilerData → result → wavefrontCornea → zernikes → zernikes12

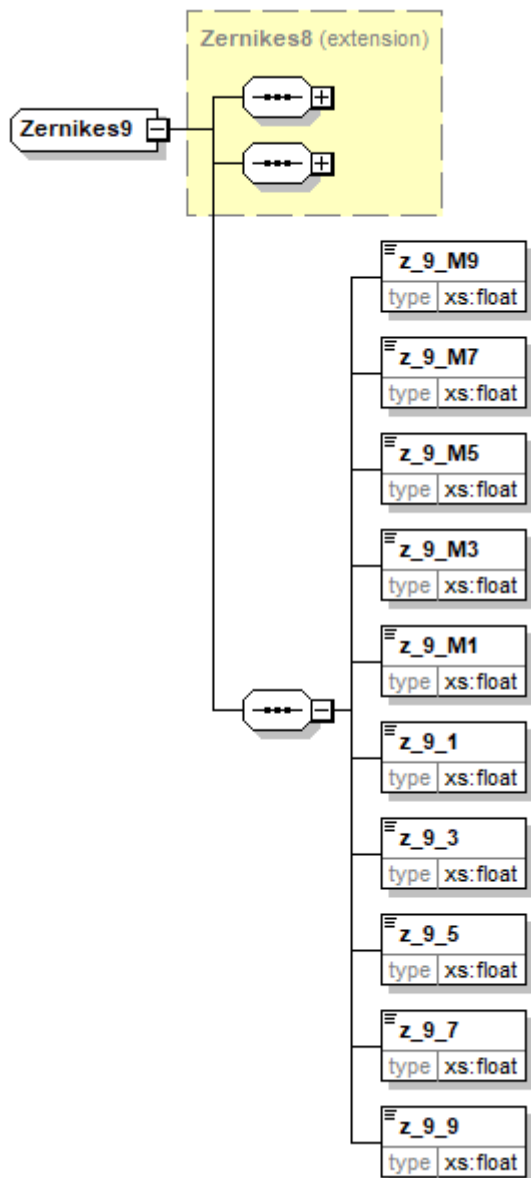

<b>base element</b>	
<b>type</b>	zernikes8
<b>z_9_M9</b>	
<b>type</b>	float
<b>unity</b>	
<b>occurs</b>	1
<b>description</b>	
<b>z_9_M7</b>	
<b>type</b>	float
<b>unity</b>	
<b>occurs</b>	1

<b>z_9_M7</b>	
<b>description</b>	
<b>z_9_M5</b>	
<b>type</b>	float
<b>unity</b>	
<b>occurs</b>	1
<b>description</b>	
<b>z_9_M3</b>	
<b>type</b>	float
<b>unity</b>	
<b>occurs</b>	1
<b>description</b>	
<b>z_9_M1</b>	
<b>type</b>	float
<b>unity</b>	
<b>occurs</b>	1
<b>description</b>	
<b>z_9_1</b>	
<b>type</b>	float
<b>unity</b>	
<b>occurs</b>	1
<b>description</b>	
<b>z_9_3</b>	
<b>type</b>	float
<b>unity</b>	
<b>occurs</b>	1
<b>description</b>	
<b>z_9_5</b>	
<b>type</b>	float
<b>unity</b>	
<b>occurs</b>	1
<b>description</b>	
<b>z_9_7</b>	
<b>type</b>	float
<b>unity</b>	
<b>occurs</b>	1
<b>description</b>	
<b>z_9_9</b>	
<b>type</b>	float
<b>unity</b>	
<b>occurs</b>	1
<b>description</b>	

```
<xs:complexType name="Zernikes9">  
  <xs:complexContent mixed="false">
```

```
<xs:extension base="Zernikes8">  
  <xs:sequence>  
    <xs:element name="z_9_M9" type="xs:float" />  
    <xs:element name="z_9_M7" type="xs:float" />  
    <xs:element name="z_9_M5" type="xs:float" />  
    <xs:element name="z_9_M3" type="xs:float" />  
    <xs:element name="z_9_M1" type="xs:float" />  
    <xs:element name="z_9_1" type="xs:float" />  
    <xs:element name="z_9_3" type="xs:float" />  
    <xs:element name="z_9_5" type="xs:float" />  
    <xs:element name="z_9_7" type="xs:float" />  
    <xs:element name="z_9_9" type="xs:float" />  
  </xs:sequence>  
</xs:extension>  
</xs:complexContent>  
</xs:complexType>
```

From:  
<https://wiki.b2boptic.com/> - **wiki.b2boptic.com**

Permanent link:  
<https://wiki.b2boptic.com/en:lensorder:version010605:complextypes:zernikes9:zernikes12cornea>

Last update: **2024/07/09 04:10**

