

zernikes12 (Zernikes12)

b2boptic → items → item → pair → patient → iProfilerData → result → wavefrontEye → zernikes → zernikes12

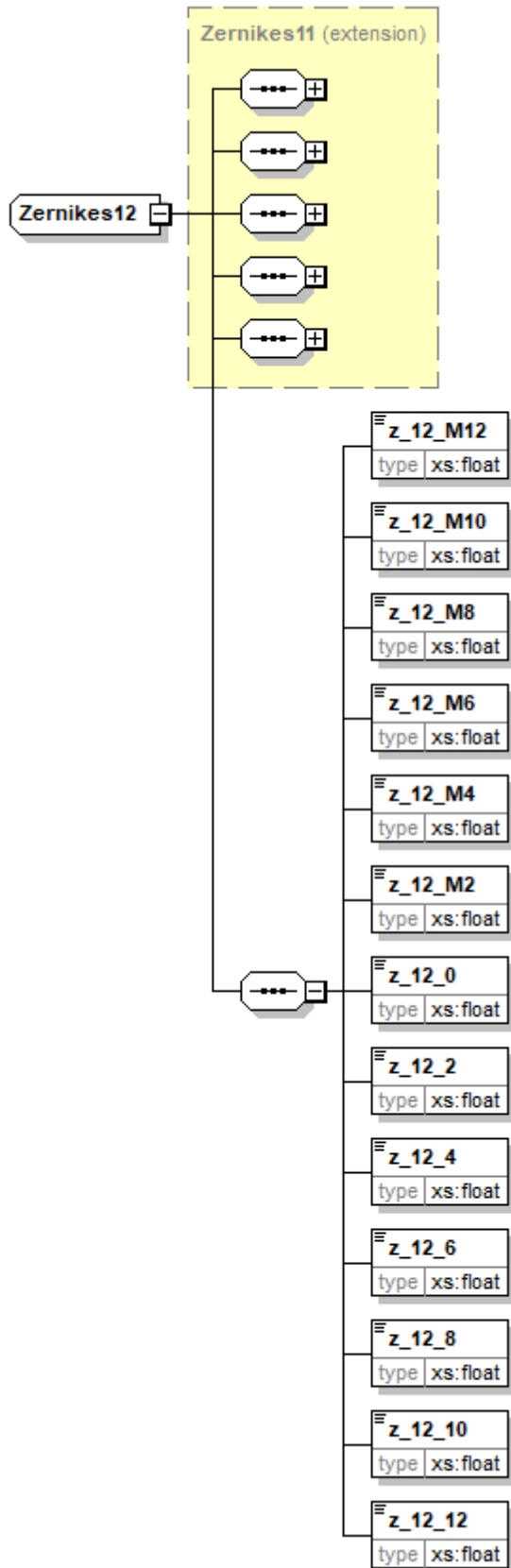

base element	
type	zernikes11
z_12_M12	
type	float
unity	
occurs	1
description	
z_12_M10	
type	float
unity	
occurs	1
description	
z_12_M8	
type	float
unity	
occurs	1
description	
z_12_M6	
type	float
unity	
occurs	1
description	
z_12_M4	
type	float
unity	
occurs	1
description	
z_12_M2	
type	float
unity	
occurs	1
description	
z_12_0	
type	float
unity	
occurs	1
description	
z_12_2	
type	float
unity	
occurs	1
description	
z_12_4	
type	float

z_12_4	
unity	
occurs	1
description	
z_12_6	
type	float
unity	
occurs	1
description	
z_12_8	
type	float
unity	
occurs	1
description	
z_12_10	
type	float
unity	
occurs	1
description	
z_12_12	
type	float
unity	
occurs	1
description	

```

<xs:complexType name="Zernikes12">
  <xs:complexContent mixed="false">
    <xs:extension base="Zernikes11">
      <xs:sequence>
        <xs:element name="z_12_M12" type="xs:float" />
        <xs:element name="z_12_M10" type="xs:float" />
        <xs:element name="z_12_M8" type="xs:float" />
        <xs:element name="z_12_M6" type="xs:float" />
        <xs:element name="z_12_M4" type="xs:float" />
        <xs:element name="z_12_M2" type="xs:float" />
        <xs:element name="z_12_0" type="xs:float" />
        <xs:element name="z_12_2" type="xs:float" />
        <xs:element name="z_12_4" type="xs:float" />
        <xs:element name="z_12_6" type="xs:float" />
        <xs:element name="z_12_8" type="xs:float" />
        <xs:element name="z_12_10" type="xs:float" />
        <xs:element name="z_12_12" type="xs:float" />
      </xs:sequence>
    </xs:extension>
  </xs:complexContent>
</xs:complexType>

```

From:
<https://wiki.b2boptic.com/> - **wiki.b2bOptic.com**

Permanent link:
<https://wiki.b2boptic.com/en:lensorder:version010605:complextypes:zernikes12:wavefronteye>

Last update: **2024/07/09 04:10**

