

diameter (Diameter)

b2boptic → items → item → pair → lens → geometry → diameter

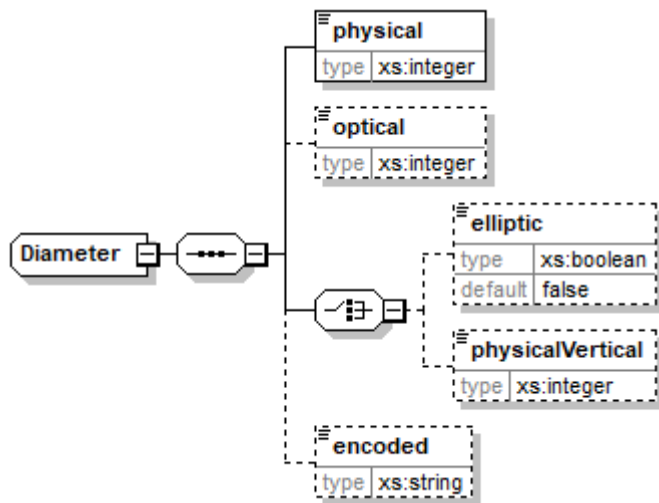

physical	
type	integer
unity	mm
occurs	1
description	physical diameter of the lens
optical	
type	integer
unity	mm
occurs	0..1
description	optical diameter of the lens
elliptic	
type	boolean
occurs	0..1 (not together with physicalVertical)
default	false
description	elliptic diameter of the lens
physicalVertical	
type	integer
unity	mm
occurs	0..1 (not together with elliptic)
description	vertical diameter of the physical lens
encoded	
type	string
occurs	0..1
description	diameter order code of catalog

```

<xs:complexType name="Diameter">
  <xs:sequence>
    <xs:element name="physical" type="xs:integer" />
    <xs:element minOccurs="0" name="optical" type="xs:integer" />
  
```

```
<xs:choice>
  <xs:element minOccurs="0" default="false" name="elliptic"
type="xs:boolean" />
  <xs:element minOccurs="0" name="physicalVertical" type="xs:integer" />
</xs:choice>
<xs:element minOccurs="0" name="encoded" type="xs:string" />
</xs:sequence>
</xs:complexType>
```

From:
<https://wiki.b2boptic.com/> - **wiki.b2bOptic.com**

Permanent link:
<https://wiki.b2boptic.com/en:lensorder:version010605:complextypes:diameter:pair>

Last update: **2024/07/09 04:10**

