

# zernikes10 (Zernikes9)

b2boptic → items → item → pair → patient → iProfilerData → result → wavefrontEye → zernikes → zernikes10

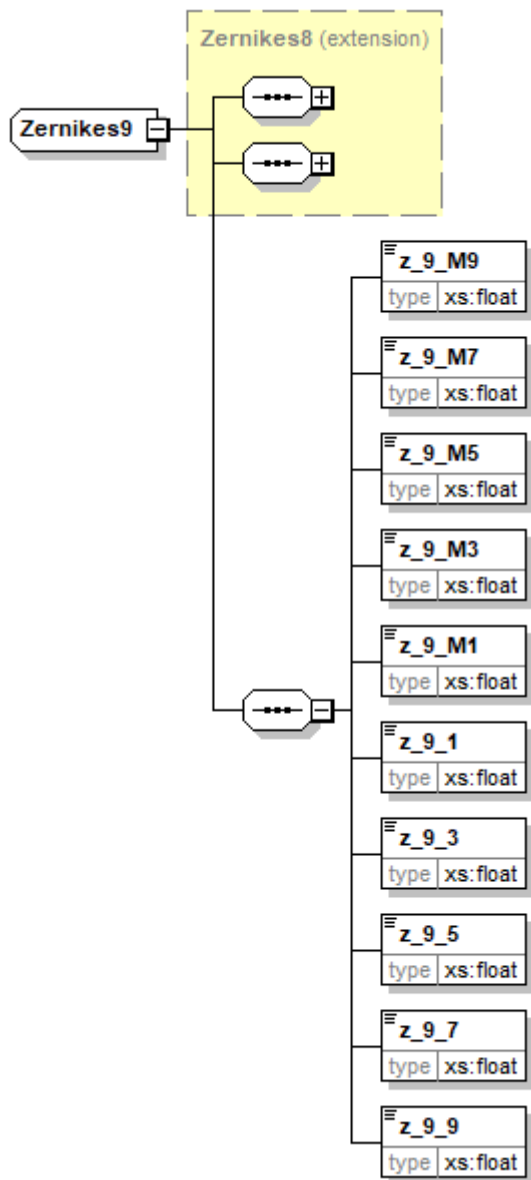

<b>base element</b>	
<b>type</b>	zernikes8
<b>z_9_M9</b>	
<b>type</b>	float
<b>unity</b>	
<b>occurs</b>	1
<b>description</b>	
<b>z_9_M7</b>	
<b>type</b>	float
<b>unity</b>	
<b>occurs</b>	1

<b>z_9_M7</b>	
<b>description</b>	
<b>z_9_M5</b>	
<b>type</b>	float
<b>unity</b>	
<b>occurs</b>	1
<b>description</b>	
<b>z_9_M3</b>	
<b>type</b>	float
<b>unity</b>	
<b>occurs</b>	1
<b>description</b>	
<b>z_9_M1</b>	
<b>type</b>	float
<b>unity</b>	
<b>occurs</b>	1
<b>description</b>	
<b>z_9_1</b>	
<b>type</b>	float
<b>unity</b>	
<b>occurs</b>	1
<b>description</b>	
<b>z_9_3</b>	
<b>type</b>	float
<b>unity</b>	
<b>occurs</b>	1
<b>description</b>	
<b>z_9_5</b>	
<b>type</b>	float
<b>unity</b>	
<b>occurs</b>	1
<b>description</b>	
<b>z_9_7</b>	
<b>type</b>	float
<b>unity</b>	
<b>occurs</b>	1
<b>description</b>	
<b>z_9_9</b>	
<b>type</b>	float
<b>unity</b>	
<b>occurs</b>	1
<b>description</b>	

```
<xs:complexType name="Zernikes9">
  <xs:complexContent mixed="false">
```

```
<xs:extension base="Zernikes8">
  <xs:sequence>
    <xs:element name="z_9_M9" type="xs:float" />
    <xs:element name="z_9_M7" type="xs:float" />
    <xs:element name="z_9_M5" type="xs:float" />
    <xs:element name="z_9_M3" type="xs:float" />
    <xs:element name="z_9_M1" type="xs:float" />
    <xs:element name="z_9_1" type="xs:float" />
    <xs:element name="z_9_3" type="xs:float" />
    <xs:element name="z_9_5" type="xs:float" />
    <xs:element name="z_9_7" type="xs:float" />
    <xs:element name="z_9_9" type="xs:float" />
  </xs:sequence>
</xs:extension>
</xs:complexContent>
</xs:complexType>
```

From:  
<https://wiki.b2boptic.com/> - **wiki.b2bOptic.com**

Permanent link:  
<https://wiki.b2boptic.com/en:lensorder:version010604:complextypes:zernikes9:zernikes10eye>

Last update: **2017/06/19 12:50**

