

zernikes10 (Zernikes8)

b2boptic → items → item → pair → patient → iProfilerData → result → wavefrontCornea → zernikes → zernikes10

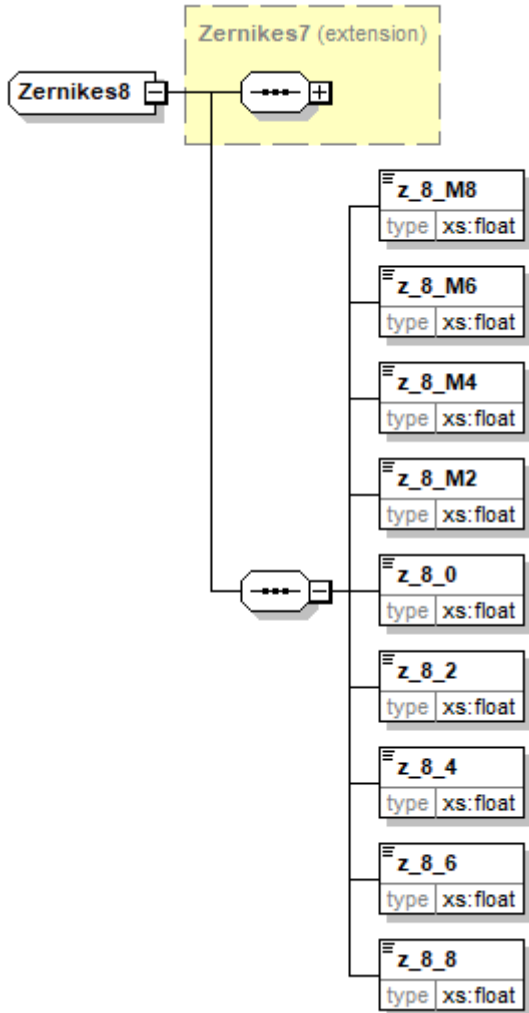

base element	
type	zernikes7
z_8_M8	
type	float
unity	
occurs	1
description	
z_8_M6	
type	float
unity	
occurs	1
description	
z_8_M4	
type	float
unity	

z_8_M4	
occurs	1
description	
z_8_M2	
type	float
unity	
occurs	1
description	
z_8_0	
type	float
unity	
occurs	1
description	
z_8_2	
type	float
unity	
occurs	1
description	
z_8_4	
type	float
unity	
occurs	1
description	
z_8_6	
type	float
unity	
occurs	1
description	
z_8_8	
type	float
unity	
occurs	1
description	

```
<xs:complexType name="Zernikes8">
  <xs:complexContent mixed="false">
    <xs:extension base="Zernikes7">
      <xs:sequence>
        <xs:element name="z_8_M8" type="xs:float" />
        <xs:element name="z_8_M6" type="xs:float" />
        <xs:element name="z_8_M4" type="xs:float" />
        <xs:element name="z_8_M2" type="xs:float" />
        <xs:element name="z_8_0" type="xs:float" />
        <xs:element name="z_8_2" type="xs:float" />
        <xs:element name="z_8_4" type="xs:float" />
        <xs:element name="z_8_6" type="xs:float" />
      </xs:sequence>
    </xs:extension>
  </xs:complexContent>
</xs:complexType>
```

```
<xs:element name="z_8_8" type="xs:float" />  
</xs:sequence>  
</xs:extension>  
</xs:complexContent>  
</xs:complexType>
```

From:

<https://wiki.b2boptic.com/> - **wiki.b2bOptic.com**

Permanent link:

<https://wiki.b2boptic.com/en:lensorder:version010604:complextypes:zernikes8:zernikes10cornea>

Last update: **2017/06/19 12:50**

