

zernikes11 (Zernikes11)

b2boptic → items → item → pair → patient → iProfilerData → result → wavefrontCornea → zernikes → zernikes11

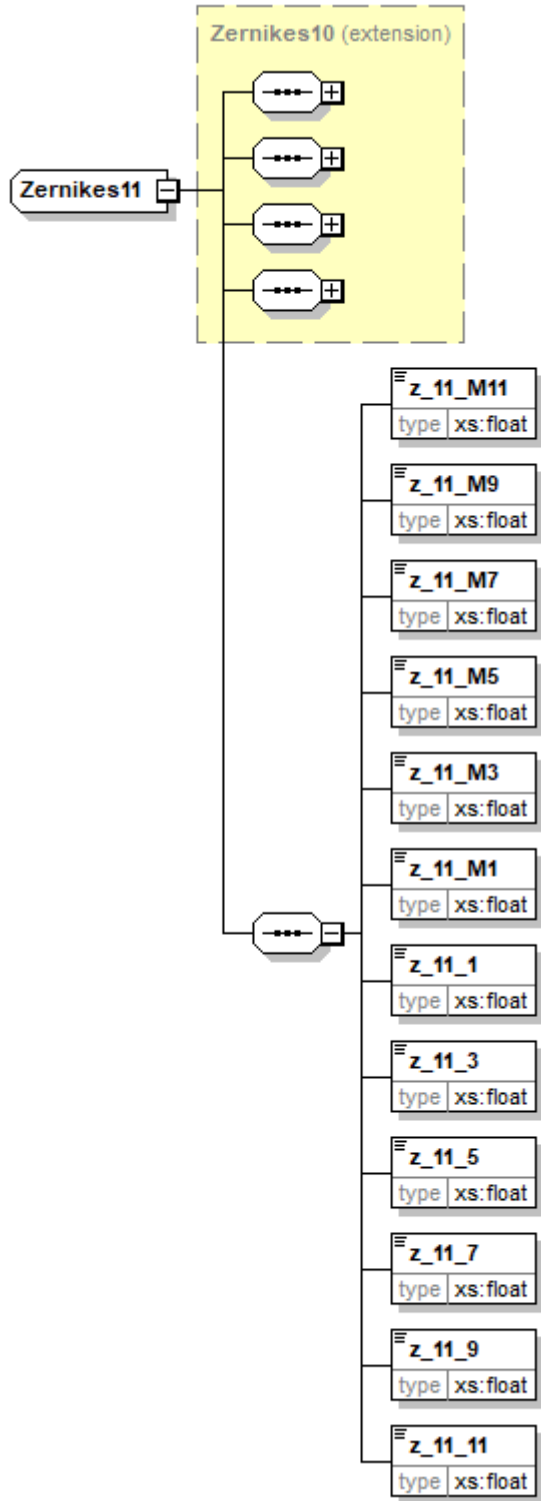

base element	
type	zernikes10
z_11_M11	
type	float

z_11_M11	
unity	
occurs	1
description	
z_11_M9	
type	float
unity	
occurs	1
description	
z_11_M7	
type	float
unity	
occurs	1
description	
z_11_M5	
type	float
unity	
occurs	1
description	
z_11_M3	
type	float
unity	
occurs	1
description	
z_11_M1	
type	float
unity	
occurs	1
description	
z_11_1	
type	float
unity	
occurs	1
description	
z_11_3	
type	float
unity	
occurs	1
description	
z_11_5	
type	float
unity	
occurs	1
description	

z_11_7	
type	float
unity	
occurs	1
description	
z_11_9	
type	float
unity	
occurs	1
description	
z_11_11	
type	float
unity	
occurs	1
description	

```

<xs:complexType name="Zernikes11">
  <xs:complexContent mixed="false">
    <xs:extension base="Zernikes10">
      <xs:sequence>
        <xs:element name="z_11_M11" type="xs:float" />
        <xs:element name="z_11_M9" type="xs:float" />
        <xs:element name="z_11_M7" type="xs:float" />
        <xs:element name="z_11_M5" type="xs:float" />
        <xs:element name="z_11_M3" type="xs:float" />
        <xs:element name="z_11_M1" type="xs:float" />
        <xs:element name="z_11_1" type="xs:float" />
        <xs:element name="z_11_3" type="xs:float" />
        <xs:element name="z_11_5" type="xs:float" />
        <xs:element name="z_11_7" type="xs:float" />
        <xs:element name="z_11_9" type="xs:float" />
        <xs:element name="z_11_11" type="xs:float" />
      </xs:sequence>
    </xs:extension>
  </xs:complexContent>
</xs:complexType>

```

From:
<https://wiki.b2boptic.com/> - **wiki.b2bOptic.com**

Permanent link:
<https://wiki.b2boptic.com/en:lensorder:version010604:complextypes:zernikes11:wavefrontcornea>

Last update: **2017/06/19 12:52**

