

drillHoles (DrillHoles)

b2boptic → items → item → pair → frame → shape → drillHoles

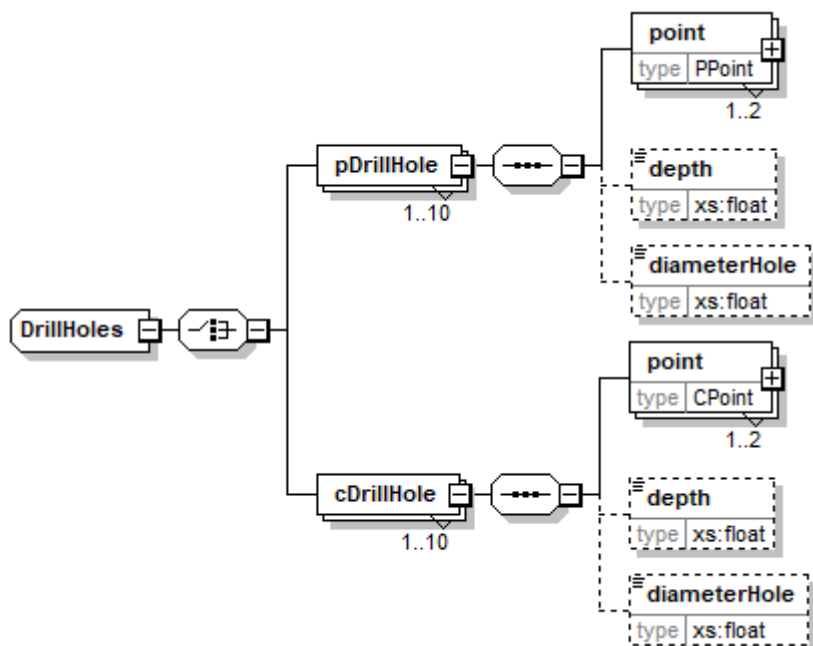

pDrillHole	
occurs	1..10 (not together with cDrillHole)
description	

point (element of pDrillHole)

type	PPoint
occurs	1..2
description	

depth (element of pDrillHole)

type	float
unity	mm
occurs	0..1
description	

diameterHole (element of pDrillHole)

type	float
unity	mm
occurs	0..1
description	

cDrillHole	
occurs	1..10 (not together with pDrillHole)
description	

point (element of cDrillHole)

type	CPoint
occurs	1..2
description	

depth (element of cDrillHole)	
type	float
unity	mm
occurs	0..1
description	

diameterHole (element of cDrillHole)	
type	float
unity	mm
occurs	0..1
description	

```
<xs:complexType name="DrillHoles">
  <xs:choice>
    <xs:element maxOccurs="10" name="pDrillHole">
      <xs:complexType>
        <xs:sequence>
          <xs:element maxOccurs="2" name="point" type="PPoint" />
          <xs:element minOccurs="0" name="depth" type="xs:float" />
          <xs:element minOccurs="0" name="diameterHole" type="xs:float" />
        </xs:sequence>
      </xs:complexType>
    </xs:element>
    <xs:element maxOccurs="10" name="cDrillHole">
      <xs:complexType>
        <xs:sequence>
          <xs:element maxOccurs="2" name="point" type="CPoint" />
          <xs:element minOccurs="0" name="depth" type="xs:float" />
          <xs:element minOccurs="0" name="diameterHole" type="xs:float" />
        </xs:sequence>
      </xs:complexType>
    </xs:element>
  </xs:choice>
</xs:complexType>
```

From: <https://wiki.b2boptic.com/> - **wiki.b2bOptic.com**

Permanent link: <https://wiki.b2boptic.com/en:lensorder:version010604:complextypes:drillholes>

Last update: **2017/06/19 12:41**

