

contact (ContactInfo)

b2boptic → items → item → parties → contact

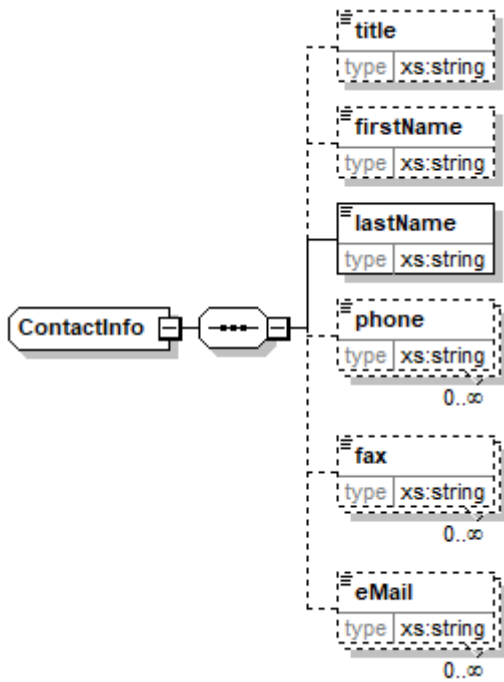

title	
type	string
occurs	0..1
description	
firstName	
type	string
occurs	0..1
description	
lastName	
type	string
occurs	1
description	
phone	
type	string
occurs	0..n
description	
fax	
type	string
occurs	0..n
description	
eMail	
type	string
occurs	0..n
description	

```
<xs:complexType name="ContactInfo">
  <xs:sequence>
    <xs:element name="title" type="xs:string" minOccurs="0"/>
    <xs:element name="firstName" type="xs:string" minOccurs="0"/>
    <xs:element name="lastName" type="xs:string"/>
    <xs:element name="phone" type="xs:string" minOccurs="0"
maxOccurs="unbounded"/>
    <xs:element name="fax" type="xs:string" minOccurs="0"
maxOccurs="unbounded"/>
    <xs:element name="eMail" type="xs:string" minOccurs="0"
maxOccurs="unbounded"/>
  </xs:sequence>
</xs:complexType>
```

From:
<https://wiki.b2boptic.com/> - **wiki.b2bOptic.com**

Permanent link:
<https://wiki.b2boptic.com/en:lensorder:version010604:complextypes:contactinfo:item>

Last update: **2017/06/19 12:39**

