

# zernikes11 (Zernikes11)

b2boptic → items → item → pair → patient → iProfilerData → result → wavefrontEye → zernikes → zernikes11

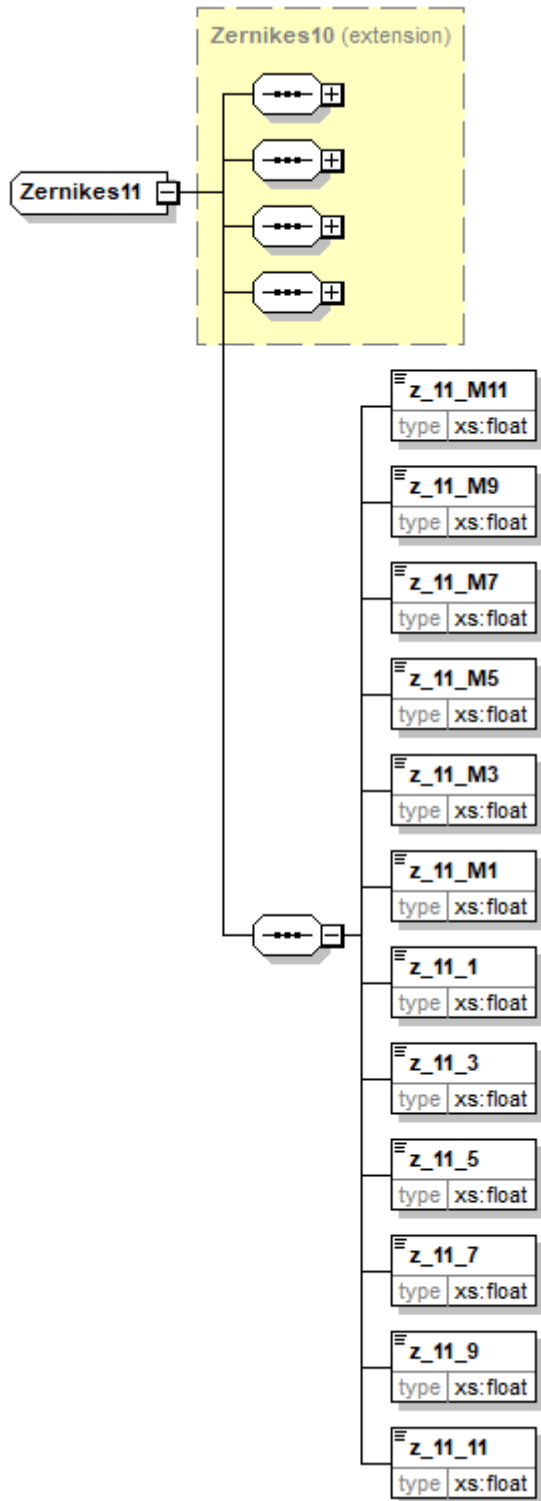

<b>base element</b>	
<b>type</b>	zernikes10
<b>z_11_M11</b>	
<b>type</b>	float

<b>z_11_M11</b>	
<b>unity</b>	
<b>occurs</b>	1
<b>description</b>	
<b>z_11_M9</b>	
<b>type</b>	float
<b>unity</b>	
<b>occurs</b>	1
<b>description</b>	
<b>z_11_M7</b>	
<b>type</b>	float
<b>unity</b>	
<b>occurs</b>	1
<b>description</b>	
<b>z_11_M5</b>	
<b>type</b>	float
<b>unity</b>	
<b>occurs</b>	1
<b>description</b>	
<b>z_11_M3</b>	
<b>type</b>	float
<b>unity</b>	
<b>occurs</b>	1
<b>description</b>	
<b>z_11_M1</b>	
<b>type</b>	float
<b>unity</b>	
<b>occurs</b>	1
<b>description</b>	
<b>z_11_1</b>	
<b>type</b>	float
<b>unity</b>	
<b>occurs</b>	1
<b>description</b>	
<b>z_11_3</b>	
<b>type</b>	float
<b>unity</b>	
<b>occurs</b>	1
<b>description</b>	
<b>z_11_5</b>	
<b>type</b>	float
<b>unity</b>	
<b>occurs</b>	1
<b>description</b>	

<b>z_11_7</b>	
<b>type</b>	float
<b>unity</b>	
<b>occurs</b>	1
<b>description</b>	
<b>z_11_9</b>	
<b>type</b>	float
<b>unity</b>	
<b>occurs</b>	1
<b>description</b>	
<b>z_11_11</b>	
<b>type</b>	float
<b>unity</b>	
<b>occurs</b>	1
<b>description</b>	

```

<xs:complexType name="Zernikes11">
  <xs:complexContent mixed="false">
    <xs:extension base="Zernikes10">
      <xs:sequence>
        <xs:element name="z_11_M11" type="xs:float" />
        <xs:element name="z_11_M9" type="xs:float" />
        <xs:element name="z_11_M7" type="xs:float" />
        <xs:element name="z_11_M5" type="xs:float" />
        <xs:element name="z_11_M3" type="xs:float" />
        <xs:element name="z_11_M1" type="xs:float" />
        <xs:element name="z_11_1" type="xs:float" />
        <xs:element name="z_11_3" type="xs:float" />
        <xs:element name="z_11_5" type="xs:float" />
        <xs:element name="z_11_7" type="xs:float" />
        <xs:element name="z_11_9" type="xs:float" />
        <xs:element name="z_11_11" type="xs:float" />
      </xs:sequence>
    </xs:extension>
  </xs:complexContent>
</xs:complexType>

```

From: <https://wiki.b2boptic.com/> - [wiki.b2boptic.com](https://wiki.b2boptic.com/)

Permanent link: <https://wiki.b2boptic.com/en:lensorder:version010603:complextypes:zernikes11:wavefronteye>

Last update: **2017/06/16 17:45**

