

curve (Curve)

b2boptic → items → item → pair → lens → geometry → curve

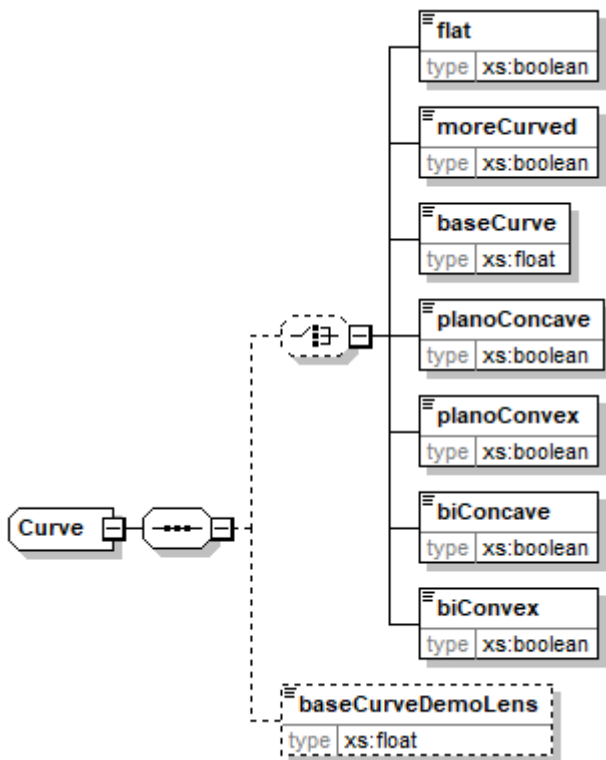

flat	
type	boolean
occurs	0..1 (not together with moreCurved, baseCurve, planoConcave, planoConvex, biConcave or biConvex)
description	next flatter base curve
moreCurved	
type	boolean
occurs	0..1 (not together with flat, baseCurve, planoConcave, planoConvex, biConcave or biConvex)
description	next curved base curve
baseCurve	
type	float
unity	dpt
occurs	0..1 (not together with flat, moreCurved, planoConcave, planoConvex, biConcave or biConvex)
description	base curve of the ordered lens as value
planoConcave	
type	boolean
occurs	0..1 (not together with flat, moreCurved, baseCurve, planoConvex, biConcave or biConvex)
description	
planoConvex	
type	boolean

planoConvex	
occurs	0..1 (not together with flat, moreCurved, baseCurve, planoConcave, biConcave or biConvex)
description	
biConcave	
type	boolean
occurs	0..1 (not together with flat, moreCurved, baseCurve, planoConcave, planoConvex or biConvex)
description	
biConvex	
type	boolean
occurs	0..1 (not together with flat, moreCurved, baseCurve, planoConcave, planoConvex or biConcave)
description	
baseCurveDemoLens	
type	float
unity	dpt
occurs	0..1
description	base curve of the demo lens as value

```
<xs:complexType name="Curve">
  <xs:sequence>
    <xs:choice minOccurs="0">
      <xs:element name="flat" type="xs:boolean" />
      <xs:element name="moreCurved" type="xs:boolean" />
      <xs:element name="baseCurve" type="xs:float"/>
      <xs:element name="planoConcave" type="xs:boolean" />
      <xs:element name="planoConvex" type="xs:boolean" />
      <xs:element name="biConcave" type="xs:boolean" />
      <xs:element name="biConvex" type="xs:boolean" />
    </xs:choice>
    <xs:element name="baseCurveDemoLens" minOccurs="0"/>
  </xs:sequence>
</xs:complexType>
```

From:
<https://wiki.b2boptic.com/> - **wiki.b2bOptic.com**

Permanent link:
<https://wiki.b2boptic.com/en:lensorder:version010603:complextypes:curve>

Last update: **2017/06/16 17:14**

