

zernikes11 (Zernikes9)

b2boptic → items → item → pair → patient → iProfilerData → result → wavefrontCornea → zernikes → zernikes11

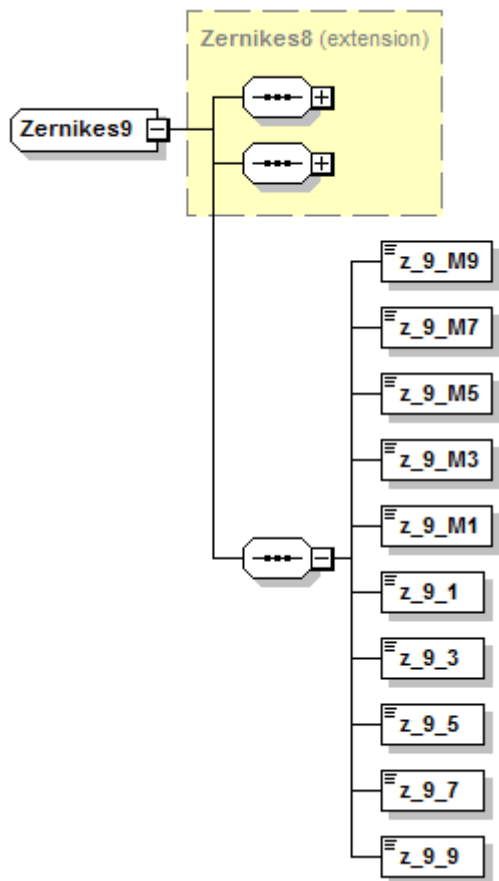

base element	
type	zernikes8
z_9_M9	
type	float
unity	
occurs	1
description	
z_9_M7	
type	float
unity	
occurs	1
description	
z_9_M5	
type	float
unity	
occurs	1
description	

z_9_M3	
type	float
unity	
occurs	1
description	
z_9_M1	
type	float
unity	
occurs	1
description	
z_9_1	
type	float
unity	
occurs	1
description	
z_9_3	
type	float
unity	
occurs	1
description	
z_9_5	
type	float
unity	
occurs	1
description	
z_9_7	
type	float
unity	
occurs	1
description	
z_9_9	
type	float
unity	
occurs	1
description	

```
<xs:complexType name="Zernikes9">
  <xs:complexContent mixed="false">
    <xs:extension base="Zernikes8">
      <xs:sequence>
        <xs:element name="z_9_M9" type="xs:float" />
        <xs:element name="z_9_M7" type="xs:float" />
        <xs:element name="z_9_M5" type="xs:float" />
        <xs:element name="z_9_M3" type="xs:float" />
        <xs:element name="z_9_M1" type="xs:float" />
        <xs:element name="z_9_1" type="xs:float" />
      </xs:sequence>
    </xs:extension>
  </xs:complexContent>
</xs:complexType>
```

```
<xs:element name="z_9_3" type="xs:float" />
<xs:element name="z_9_5" type="xs:float" />
<xs:element name="z_9_7" type="xs:float" />
<xs:element name="z_9_9" type="xs:float" />
</xs:sequence>
</xs:extension>
</xs:complexContent>
</xs:complexType>
```

From:

<https://wiki.b2boptic.com/> - **wiki.b2bOptic.com**

Permanent link:

<https://wiki.b2boptic.com/en:lensorder:version010602:complextypes:zernikes9:zernikes11cornea>

Last update: **2016/05/04 13:00**

