

zernikes11 (Zernikes10)

b2boptic → items → item → pair → patient → iProfilerData → result → wavefrontCornea → zernikes → zernikes11

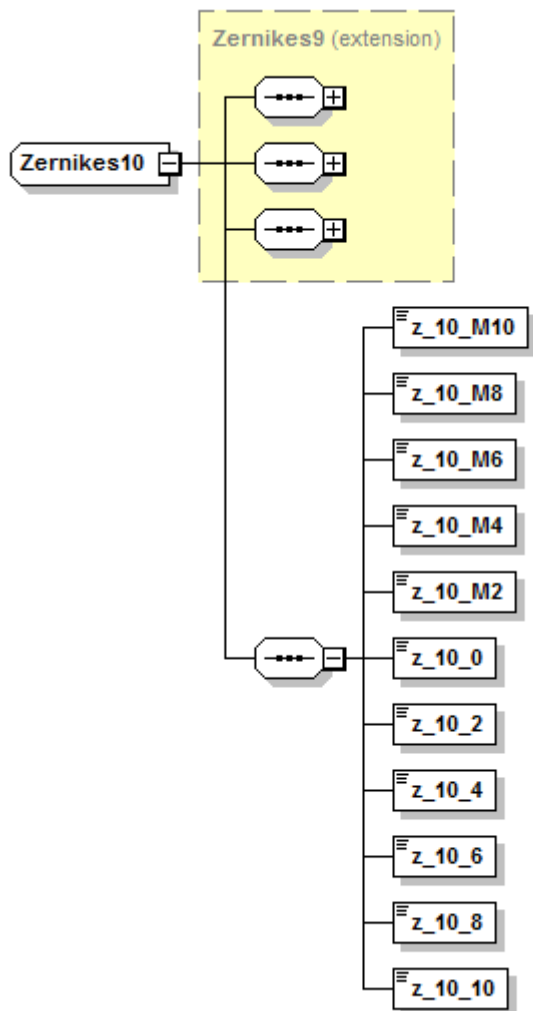

base element	
type	zernikes9
z_10_M10	
type	float
unity	
occurs	1
description	
z_10_M8	
type	float
unity	
occurs	1
description	
z_10_M6	
type	float
unity	

z_10_M6	
occurs	1
description	
z_10_M4	
type	float
unity	
occurs	1
description	
z_10_M2	
type	float
unity	
occurs	1
description	
z_10_0	
type	float
unity	
occurs	1
description	
z_10_2	
type	float
unity	
occurs	1
description	
z_10_4	
type	float
unity	
occurs	1
description	
z_10_6	
type	float
unity	
occurs	1
description	
z_10_8	
type	float
unity	
occurs	1
description	
z_10_10	
type	float
unity	
occurs	1
description	

<xs:complexType name="Zernikes10">

```
<xs:complexContent mixed="false">
  <xs:extension base="Zernikes9">
    <xs:sequence>
      <xs:element name="z_10_M10" type="xs:float" />
      <xs:element name="z_10_M8" type="xs:float" />
      <xs:element name="z_10_M6" type="xs:float" />
      <xs:element name="z_10_M4" type="xs:float" />
      <xs:element name="z_10_M2" type="xs:float" />
      <xs:element name="z_10_0" type="xs:float" />
      <xs:element name="z_10_2" type="xs:float" />
      <xs:element name="z_10_4" type="xs:float" />
      <xs:element name="z_10_6" type="xs:float" />
      <xs:element name="z_10_8" type="xs:float" />
      <xs:element name="z_10_10" type="xs:float" />
    </xs:sequence>
  </xs:extension>
</xs:complexContent>
</xs:complexType>
```

From:
<https://wiki.b2boptic.com/> - **wiki.b2bOptic.com**

Permanent link:
<https://wiki.b2boptic.com/en:lensorder:version010600:complextypes:zernikes10:zernikes11cornea>

Last update: **2014/06/13 15:43**

