

decentration (Decentration)

b2boptic → items → item → pair → lens → geometry → decentration

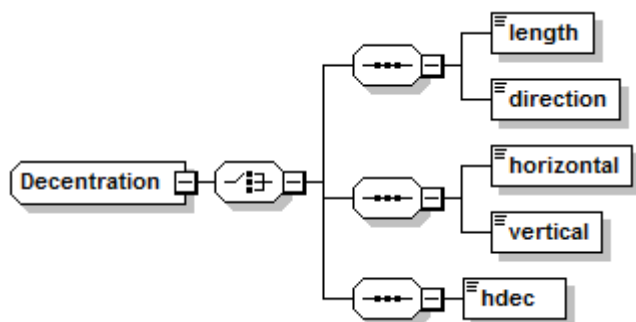

length	
type	float
unity	mm
occurs	1 (not together with horizontal, vertical or hdec)
description	
direction	
type	integer
unity	degree
occurs	1 (not together with horizontal, vertical or hdec)
description	
horizontal	
type	float
unity	mm
occurs	1 (not together with length, direction or hdec)
description	
vertical	
type	float
unity	mm
occurs	1 (not together with length, direction or hdec)
description	
hdec	
type	float
unity	mm
occurs	1 (not together with length, direction, horizontal or vertical)
description	

```

<xs:complexType name="Decentration">
  <xs:choice>
    <xs:sequence>
      <xs:element name="length" type="xs:float" />
      <xs:element name="direction" type="xs:integer" />
    </xs:sequence>
    <xs:sequence>

```

```
<xs:element name="horizontal" type="xs:float" />
<xs:element name="vertical" type="xs:float" />
</xs:sequence>
<xs:sequence>
  <xs:element name="hdec" type="xs:float" />
</xs:sequence>
</xs:choice>
</xs:complexType>
```

From:
<https://wiki.b2boptic.com/> - **wiki.b2bOptic.com**

Permanent link:
<https://wiki.b2boptic.com/en:lensorder:version010600:complextypes:decentration>

Last update: **2014/06/10 18:35**

