

B2BCatalogRefractionSteps

b2bOpticLensCatalog→lensRanges→lensRange→refractions

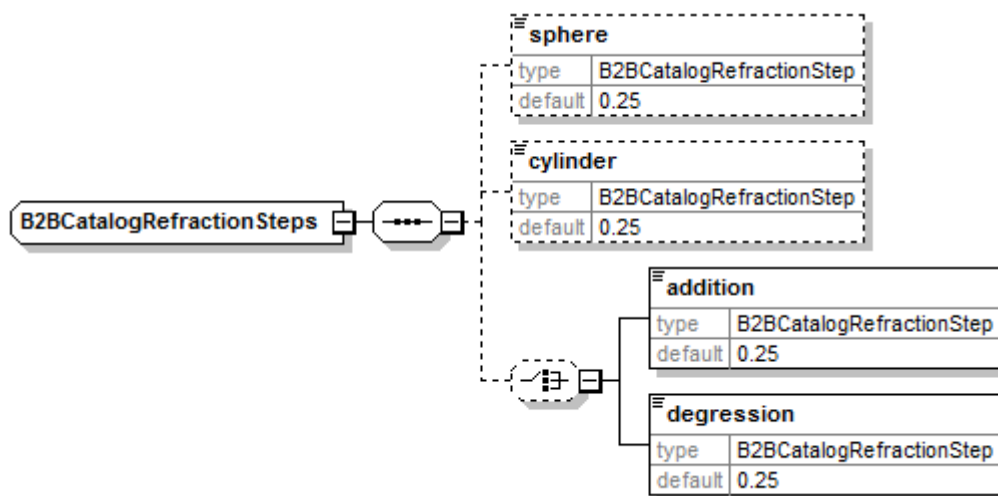

sphere	
type	B2BCatalogRefractionStep
unity	
occurs	0..1
description	available steps for the sphere range
cylinder	
type	B2BCatalogRefractionStep
unity	
occurs	0..1
description	available steps for the cylinder range
addition	
type	B2BCatalogRefractionStep
unity	
occurs	1
description	available steps for the addition range
degression	
type	B2BCatalogRefractionStep
unity	
occurs	1
description	available steps for the degression range

```

<xs:complexType name="B2BCatalogRefractionSteps">
  <xs:sequence>
    <xs:element default="0.25" minOccurs="0" name="sphere"
type="B2BCatalogRefractionStep"/>
    <xs:element default="0.25" minOccurs="0" name="cylinder"
type="B2BCatalogRefractionStep"/>
    <xs:choice minOccurs="0">
      <xs:element default="0.25" name="addition"

```

```
type="B2BCatalogRefractionStep"/>
  <xs:element default="0.25" name="degression"
type="B2BCatalogRefractionStep"/>
</xs:choice>
</xs:sequence>
</xs:complexType>
```

From:
<http://wiki.b2boptic.com/> - **wiki.b2bOptic.com**

Permanent link:
<http://wiki.b2boptic.com/en:lenscatalog:version070000:complextypes:b2bcatalogrefractionsteps>

Last update: **2017/03/16 10:30**

