

rxDataFn (RXDataTypeFarNear)

b2bOpticJobData → items → item → pair → lens → rxDataFn

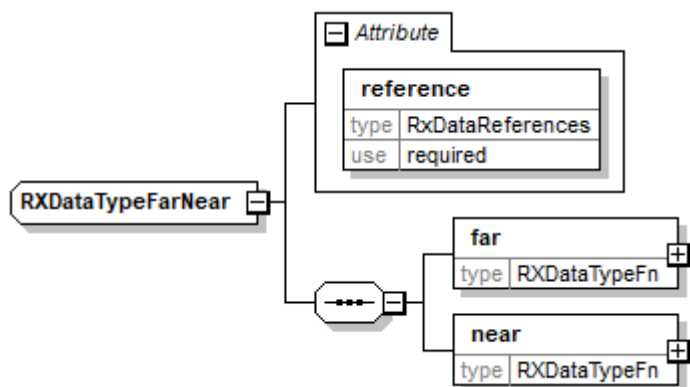

reference	
type	RxDataReferences
use	required
description	
far	
type	RXDataTypeFn
occurs	1
near	
type	RXDataTypeFn
occurs	1

```

<xs:complexType name="RXDataTypeFarNear">
  <xs:sequence>
    <xs:element name="far" type="RXDataTypeFn" />
    <xs:element name="near" type="RXDataTypeFn" />
  </xs:sequence>
  <xs:attribute name="reference" type="RxDataReferences" use="required" />
</xs:complexType>
  
```

From: <https://wiki.b2boptic.com/> - wiki.b2boptic.com

Permanent link: <https://wiki.b2boptic.com/en/jobdata:version010604:complextypes:rxdatatypefarnear>

Last update: 2020/05/15 11:17

